

SENKO



*Savršena
toplina doma!*

KATALOG PROIZVODA

štednjaci ▪ peći ▪ kamini ▪ električni kotlovi

2025

SENKO

Senko d.o.o. je obiteljsko poduzeće, osnovano 1978. godine, koje preko trideset i pet godina predano radi na razvoju, proizvodnji i usavršavanju štednjaka, peći i kamina na drvenu biomasu. Godine kontinuiranog rasta, stalno ulaganje u nove tehnologije i potpuna predanost razvoju vlastitog inovativnog proizvoda rezultirale su time da smo danas suvremeno opremljena tvornica koja na 4000 m² proizvodnog prostora, uz stručne i iskusne djelatnike, razvija nove modele štednjaka sukladno EN normama.

Našim kupcima možemo garantirati vrhunsku kvalitetu proizvoda jer unutar SENKO proizvodnje imamo zaokružen cjelokupni proces: od vlastitog odjela razvoja proizvoda, pripreme dijelova laserskim rezanjem i probijanjem, CNC robotskim zavarivanjem kotlova i linijskom montažom do suvremeno opremljenog laboratorija za kontrolu kvalitete i ispitivanje proizvoda.

Sve SENKO proizvode uskladili smo sa zahtjevima ECODESIGN direktive te razvili i testirali prema strogim europskim normama, ovisno o grupi proizvoda.

SENKO imenom garantiramo kvalitetu štednjaka, peći, kamina, a zadnjih godina i električnih kotlova!





Grijanje na drva Vašem će domu dati onu savršenu toplinu, ugodu i atmosferu te doprinijeti cjelokupnom pozitivnom ozračju Vašeg doma.

ZAŠTO GRIJANJE NA DRVENU BIOMASU?

- EKOLOŠKI PRIHVATLJIVO ▪ DOMAĆI ENERGENT ▪
- 100 % OBNOVLJIVA SIROVINA ▪ SIGURNO ZA UPOTREBU ▪
- LAKO UPOTREBLJAVATI I INSTALIRATI UREĐAJ ▪
- LAKO SKLADIŠTITI, BEZOPASNO ZA KUĆANSTVO I OKOLIŠ ▪

Dobro osmišljeno obnavljanje šumskih površina je održivi izvor toplinske energije koja svojim oslobađanjem prilikom izgaranja ne povećava emisiju CO₂ u atmosferi obzirom da je ista količina CO₂ potrebna za ponovni rast jednake količine drvene biomase.

PREDNOSTI SENKO ŠTEDNJAKA



Sa zadnje strane štednjaka ugrađen je dovod vanjskog zraka za izgaranje.



Vrata ložišta opremljena su vatrootpornim staklom.



SENKO štednjaci obloženi su šamotnom opekom što pozitivno utječe na kvalitetu izgaranja.



Priključak za dimnjak podesiv je po visini radi lakše montaže.



Dovođenjem sekundarnog zraka u ložište dodatno se iskorištava ogrjev i spaljuju štetni plinovi - GREEN LABEL.



Ploče za kuhanje izrađene su u debljini od 8 mm - izbjegnuto savijanje i pucanje.



Kod određenih modela za centralno grijanje podizanje rešetke ložišta omogućeno je mehanizmom za promjenu ljeta - zima.



MOGUĆNOST - ploča za kuhanje izrađena iz staklo-keramike (CERAN).



ŠTEDNJACI

ZA CENTRALNO GRIJANJE

BEZ PEĆNICE



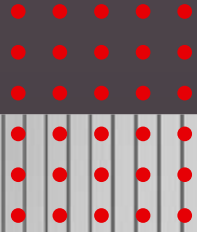

 **SENKO**
ECO design



C-20

ŠTEDNJAK
ZA CENTRALNO GRIJANJE
BEZ PEĆNICE



BASIC



INOX
MAT

BOJE



PC-2



PC-3



PC-7



» KOMBINIRANJE
sa postojećim grijanjem

A+

L/D

Nominalna toplinska snaga

15,8 - 25 kW

Dimenzije (š×d×v)

60×64×85/92 cm

Priključak dimnjaka

Ø 130 mm

C-20 PREMIUM

ŠTEDNJAK
ZA CENTRALNO GRIJANJE
BEZ PEĆNICE



» MOGUĆNOST
ploča za kuhanje
izrađena iz staklo
keramike

BOJE



PC-2



PC-3



PC-7



PC-8





C-30

ŠTEDNJAK
ZA CENTRALNO GRIJANJE
BEZ PEĆNICE



BASIC

BOJE



INOX
MAT



PC-2



PC-3



PC-7

A+

L/D

Nominalna toplinska snaga

19,1 - 35 kW

Dimenzije (š×d×v)

60×78×85/92 cm

Priključak dimnjaka

Ø 140 mm



» KOMBINIRANJE
sa postojećim grijanjem

ŠTEDNJACI

ZA CENTRALNO GRIJANJE

S PEĆNICOM





 **SENKO**
ECOdesign



C-25

ŠTEDNJAK
ZA CENTRALNO GRIJANJE
S PEČNICOM



» MOGUĆNOST izvoda
dimnjaka gore na ploči



» KOMBINIRANJE
sa postojećim grijanjem

A+

L/D

Nominalna toplinska snaga
Dimenzije (š×d×v)
Priključak dimnjaka

17,2 - 25 kW
100×64×85/92 cm
Ø 130 mm

BASIC

BOJE



INOX
MAT

PC-2

PC-3

PC-7

C-35

ŠTEDNJAK
ZA CENTRALNO GRIJANJE
S PEČNICOM



BASIC

BOJE



INOX
MAT

PC-2

PC-3

PC-7



» MOGUĆNOST izvoda
dimnjaka gore na ploči



» KOMBINIRANJE
sa postojećim grijanjem

A+

L/D

Nominalna toplinska snaga
Dimenzije (š×d×v)
Priklučak dimnjaka

21 - 35 kW
100×78×85/92 cm
Ø 150 mm



PREMIUM LINE

ŠTEDNJACI ZA CENTRALNO GRIJANJE
S PEĆNICOM

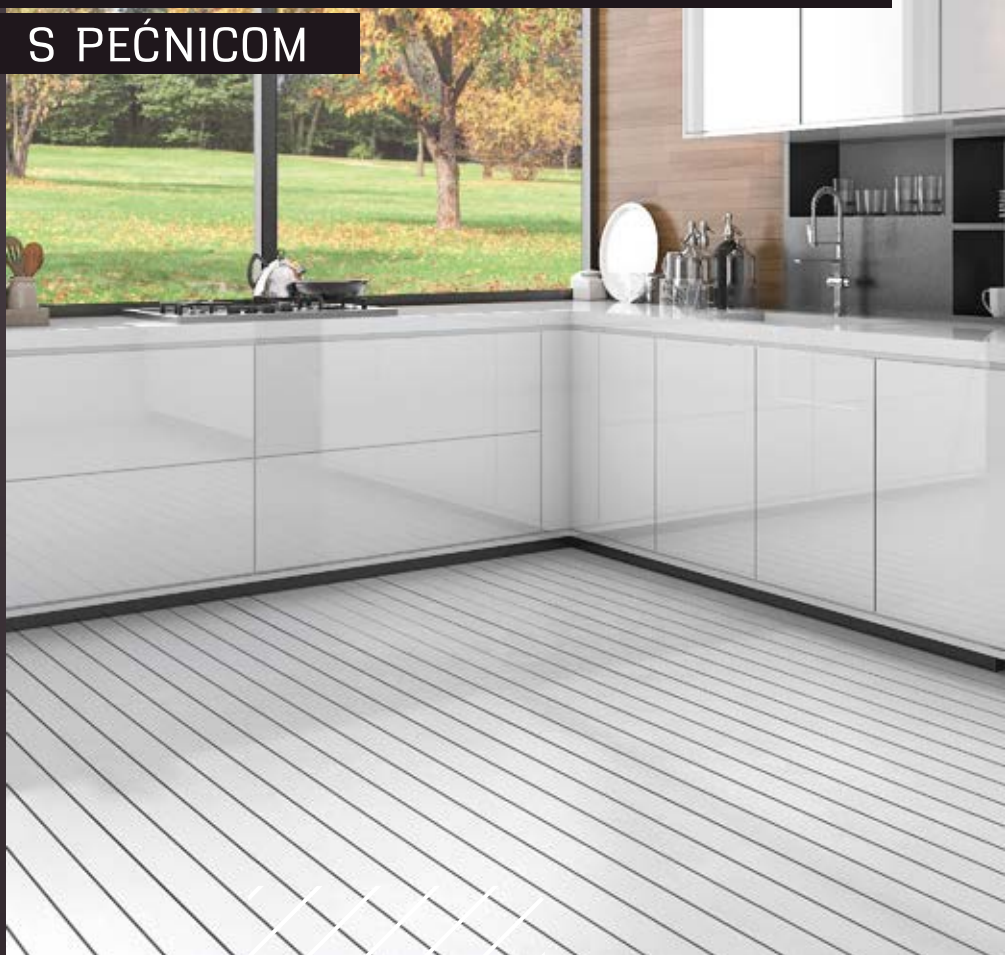



 **SENKO**
ECO design





» MOGUĆNOST
ploča za kuhanje izrađena
iz staklo keramike



BOJE



PC-2



PC-3



PC-7



PC-8

◆ ◆ ◆
C-25
PREMIUM

ŠTEDNJAK ZA
CENTRALNO GRIJANJE
S PEĆNICOM



» MOGUĆNOST izvoda
dimnjaka gore na ploči



» KOMBINIRANJE
sa postojećim grijanjem

A+

L/D

Nominalna toplinska snaga

17,2 - 25 kW

Dimenzije (š×d×v)

100×64×85/92 cm

Priključak dimnjaka

Ø 130 mm



BOJE



PC-2



PC-3



PC-7



PC-8



» MOGUĆNOST izvoda dimnjaka gore na ploči



» KOMBINIRANJE sa postojećim grijanjem

A+

L/D

Nominalna toplinska snaga

21 - 35 kW

Dimenzije (š×d×v)

100×78×85/92 cm

Priključak dimnjaka

Ø 150 mm

◀ ◀ ◀
C-35
PREMIUM

ŠTEDNJAK ZA
CENTRALNO GRIJANJE
S PEĆNICOM



– SENKO PREMIUM –

BLACK EDITION

Atraktivan. Snažan. Svestran.

Seriya štednjaka namijenjena onima koji cijene vrhunski dizajn i opremaju suvremene interijere.



» MOGUĆNOST

ploča za kuhanje izrađena iz staklo keramike
SCHOTT CERAN®

SCHOTT CERAN® ploče za kuhanje izrađene su od patentirane staklo-keramike, materijala koji kombinira estetiku stakla s ogromnom otpornošću na toplinu i stabilnost.

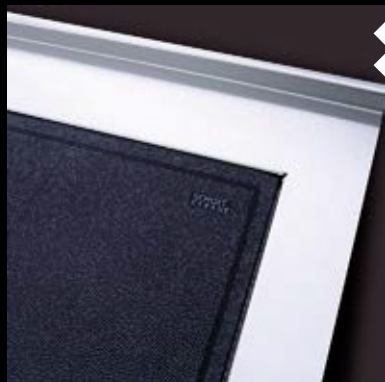

KLASIČNI

ŠTEDNJACI





SG-50

KLASIČNI ŠTEDNJAK
NA KRUTA GORIVA

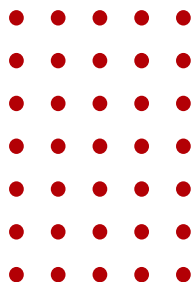

A+

L/D

Nominalna toplotna snaga
Dimenzije (š×d×v)
Priključak dimnjaka

7,2 kW
50×65×85/92 cm
Ø 120 mm

BASIC



INOX
MAT



» MOGUĆNOST
ploča za kuhanje
izrađena iz staklo
keramike



SG-60 PREMIUM

KLASIČNI ŠTEDNJAK
NA KRUTA GORIVA

BOJE



PC-2



PC-3



PC-7



PC-8



BASIC



INOX
MAT

BOJE



PC-2



PC-3



PC-7

A+

Nominalna toplinska snaga
Dimenzije (š×d×v)
Priključak dimnjaka

L/D

7,5 kW
60×65×85/92 cm
Ø 120 mm

SG-60

KLASIČNI ŠTEDNJAK
NA KRUTA GORIVA



» MOGUĆNOST izvoda
dimnjaka gore na ploči

SG-75

KLASIČNI ŠTEDNJAK
NA KRUTA GORIVA

BASIC

BOJE



INOX
MAT



PC-2



PC-3



PC-7

A+

L/D

Nominalna toplinska snaga

8,1 kW

Dimenzije (š×d×v)

75×65×85/92 cm

Priključak dimnjaka

Ø 120 mm



» MOGUĆNOST izvoda dimnjaka gore na ploči

BASIC BOJE



INOX
MAT



PC-2



PC-3



PC-7

A+

L/D

Nominalna toplinska snaga

8,6 kW

Dimenzije (š×d×v)

90×65×85/92 cm

Priključak dimnjaka

Ø 120 mm

SG-90

KLASIČNI ŠTEDNJAK
NA KRUTA GORIVA

LOŽIŠTA

KAMINA

ZA CENTRALNO GRIJANJE





C-25

LOŽIŠTE KAMINA



A+

Nominalna toplinska snaga	12 - 25 kW
Dimenzije (š×d×v)	65×75×115 cm
Priključak dimnjaka	Ø 200 mm



» KOMBINIRANJE
sa postojećim grijanjem

A

Nominalna toplinska snaga	20 - 35 kW
Dimenzije (š×d×v)	85×87×125 cm
Priključak dimnjaka	Ø 200 mm



C-35

LOŽIŠTE KAMINA



C-25

MODERN

LOŽIŠTE KAMINA



A+

Nominalna toplinska snaga	12 - 25 kW
Dimenzije (š×d×v)	65×75×115 cm
Priključak dimnjaka	Ø 200 mm

A

Nominalna toplinska snaga	20 - 35 kW
Dimenzije (š×d×v)	85×87×125 cm
Priključak dimnjaka	Ø 200 mm



» KOMBINIRANJE
sa postojećim grijanjem

C-35

MODERN

LOŽIŠTE KAMINA



KAMINSKA

SOBNA PEĆ







SENKO



KAMINSKA SOBNA PEĆ SP

Senko kaminska sobna peć kombinira eleganciju i praktičnost.

Svojim dimenzijama lako se uklapa u različite prostore. Pruža savršenu toplinu i atmosferu vatre, a njezin moderan dizajn čini prostor ugodnim za boravak.



Zadovoljava najstrože europske norme i ECOdesign direktivu te osigurava čisto sagorijevanje uz minimalnu emisiju štetnih plinova.



BOJE



PC-8

KERAMIČKA OPLATA



BIJELA



MINT
ZELENA

A

Nominalna toplinska snaga

5,2 kW

Dimenzije (š×d×v)

35×70×82,5 cm

Priključak dimnjaka

Ø 150 mm



POSEBNA PONUDA
peć s keramičkom oplatom.

PEĆI NA

PELETE



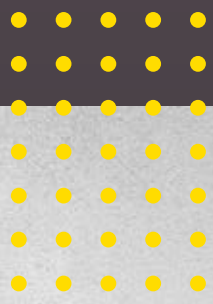



SENKO PEĆI NA PELETE

• • • • *SENKO peći na pelete koriste se za grijanje stambenih prostora i/ili centralno grijanje, a istovremeno služe i kao ukrasni element u svakom prostoru.*

• • • • • *Topli zrak pomoću ventilatora izlazi iz peći u prostoriju kroz rešetke na prednjoj strani peći. Drugim ventilatorom dovodi se primarni zrak u ložište, a dimni plinovi se istodobno odvođe iz ložišta u dimnjak. SENKO peći na pelete odlikuju se visokom učinkovitošću (91-96%) kao i vrlo niskim stupnjem zagađenja okoliša. Konstruirane su i izrađene do najsitnijih detalja da bi na najbolji način zadovoljile sve potrebe korisnika za funkcionalnošću i sigurnošću.*

SENKO PEĆI NA PELETE
za centralno grijanje imaju
najviše opreme na tržištu:

- » cirkulacijska pumpa
- » zatvorena ekspanzijska posuda
- » sigurnosni ventil 2,5 bar
- » ventil za punjenje-pražnjenje kotla
- » automatski odzračni ventil



PREDNOSTI

SENKO PEĆI NA PELETE

- ◆ *Doziranje peleta u ložište je automatsko i programirano s elektronskim sklopom pomoću pužnog dozatora.*
- ◆ *Upravljačka ploča omogućuje jednostavno rukovanje i podešavanje svih potrebnih parametara.*
- ◆ *Upravljanje daljinskim upravljačem - paljenje/gašenje, podešavanje brzine ventilatora, snage grijanja.*
- ◆ *Timer - mogućnost programiranja dnevnog/tjednog rasporeda rada peći (6 mogućih programa + 10 unaprijed definiranih profila).*
- ◆ *Mogućnost priključka vanjskog zraka potrebnog za izgaranje (izbjegavanje trošenja kisika u prostoriji u kojoj se boravi).*
- ◆ *Mogućnost reguliranja temperature grijanja prostora pomoću sobnog termostata.*
- ◆ *Sigurnosni uređaji koji automatski prekidaju doziranje peleta u ložište i javljaju alarm na upravljačkoj ploči.*
- ◆ *Mogućnost praćenja potrošnje peleta u kg/h.*
- ◆ *Mogućnost internet nadzora i upravljanja pećima, upravljanja s pametnim telefonom - WIFI modulom (OPCIJA)*

P 10 AIR MODERN

PEĆ NA PELETE ZA
GRIJANJE PROSTORA

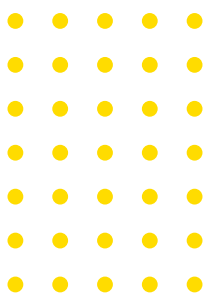

A+

AIR

Nominalna toplinska snaga
Dimenzije (š×d×v)
Priključak dimnjaka

10 kW
52×58×107 cm
Ø 80 mm

BOJE



PC-2



PC-3



PC-7



P 12

WATER + AIR MODERN

PEĆ NA PELETE ZA
CENTRALNO GRIJANJE



BOJE



PC-2



PC-3



PC-7



A++

WATER + AIR

Nominalna toplinska snaga
Dimenzije (š×d×v)
Priključak dimnjaka

13 kW
60×70×114 cm
Ø 80 mm



» KOMBINIRANJE
sa postojećim grijanjem



P 20

WATER + AIR
MODERN

PEĆ NA PELETE ZA
CENTRALNO GRIJANJE



» KOMBINIRANJE
sa postojećim grijanjem

BOJE



PC-2



PC-3



PC-7



A++

WATER + AIR

Nominalna toplinska snaga
Dimenzije (š×d×v)
Priključak dimnjaka

19 kW
66×70×126 cm
Ø 80 mm

P 10

WATER + AIR SLIM MODERN

PEĆ NA PELETE ZA
CENTRALNO GRIJANJE

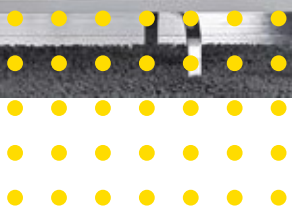

BOJE



» KOMBINIRANJE
sa postojećim grijanjem



A++

WATER + AIR

Nominalna toplinska snaga
Dimenzije (š×d×v)
Priključak dimnjaka

12 kW
91×31×115 cm
Ø 80 mm

POSEBNA PONUDA
različiti dizajn staklenih oplata
GLASS DESIGN

C-20 / C-30

C-20 PREMIUM

STRAŽNJE STRANE

BOČNA STRANA

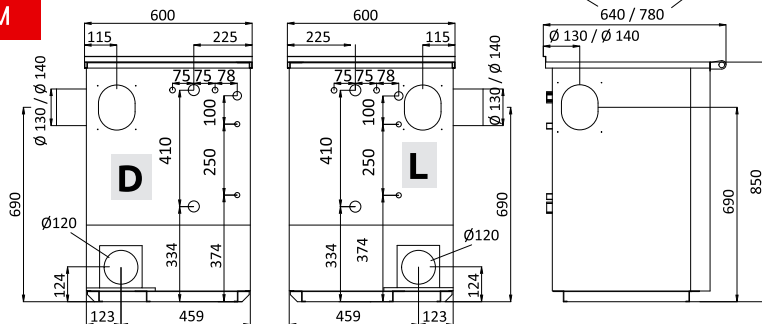

C-25 / C-35

STRAŽNJE STRANE

BOČNA STRANA

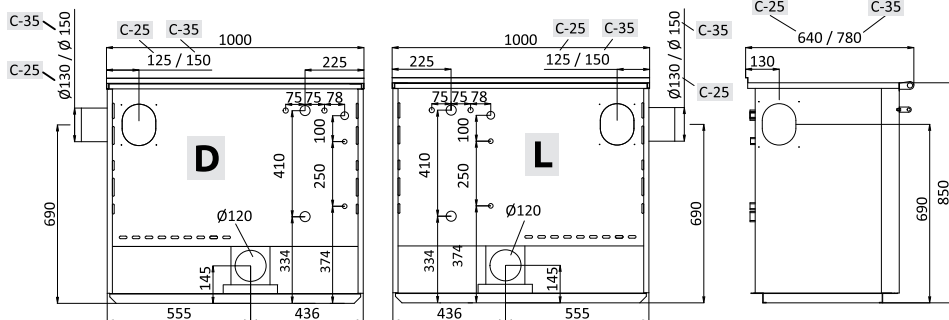

C-25 PREMIUM

C-35 PREMIUM

STRAŽNJE STRANE

BOČNA STRANA

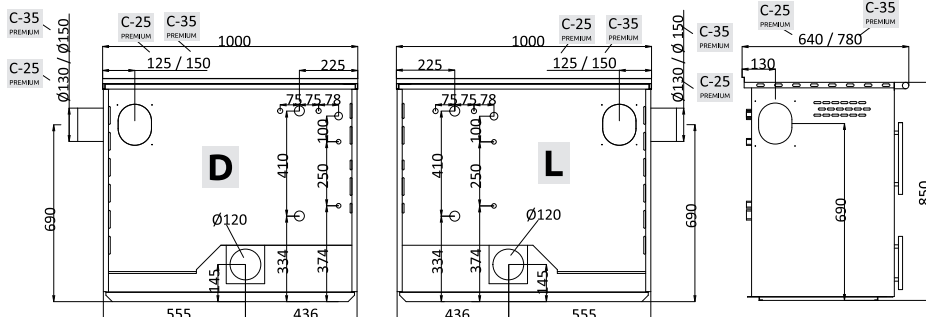

STRAŽNJA STRANA

BOČNA STRANA

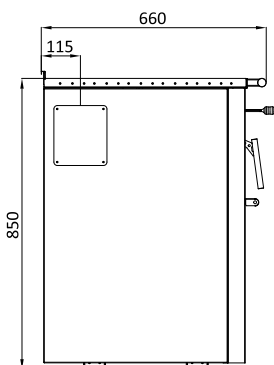
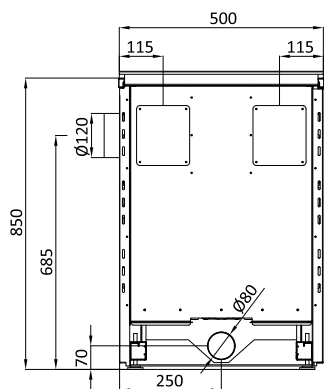

SG-50

STRAŽNJA STRANA

BOČNA STRANA

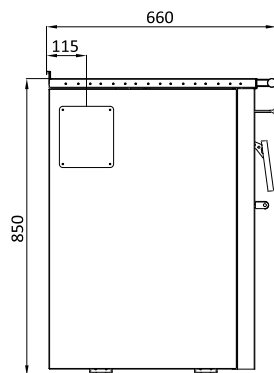
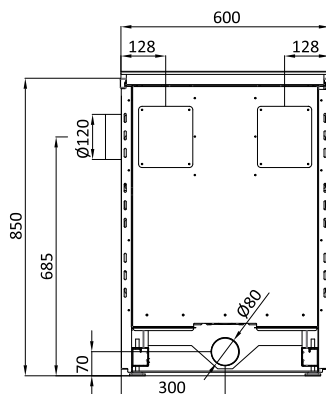

SG-60

SG-60 PREMIUM

STRAŽNJE STRANE

BOČNA STRANA

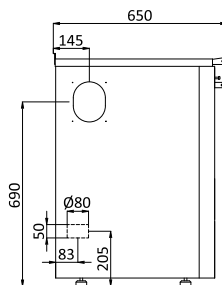
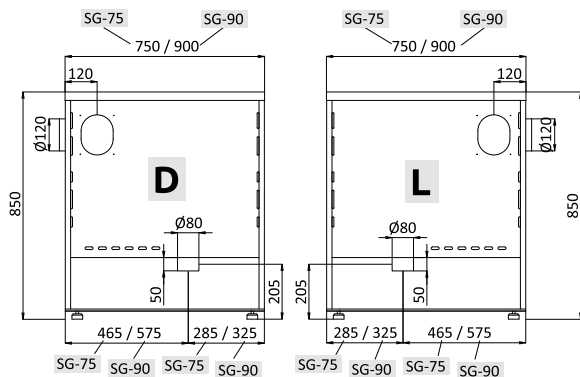

SG-75

SG-90

C-25

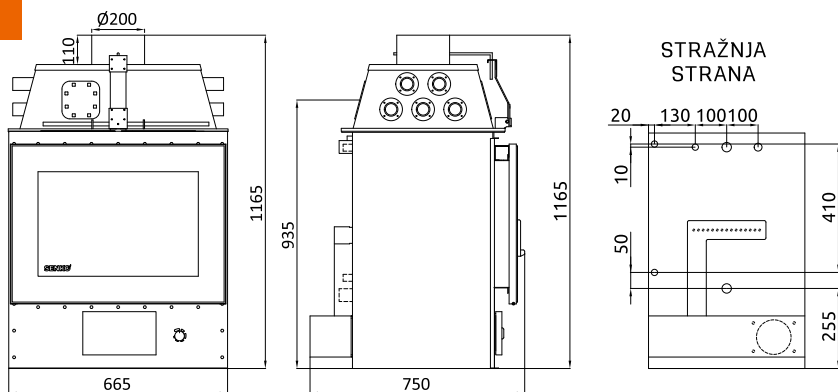

C-35

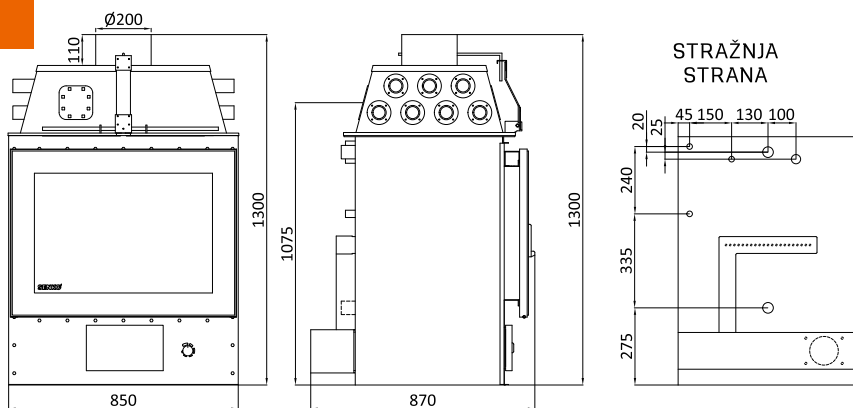

▶ KAMINSKA SOBNA PEĆ

SP

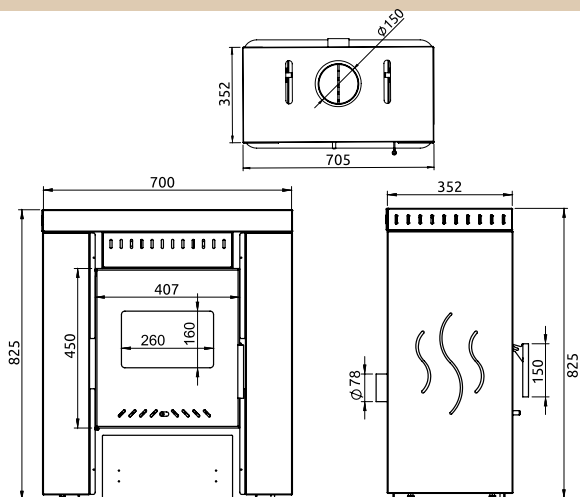

P 10 AIR MODERN

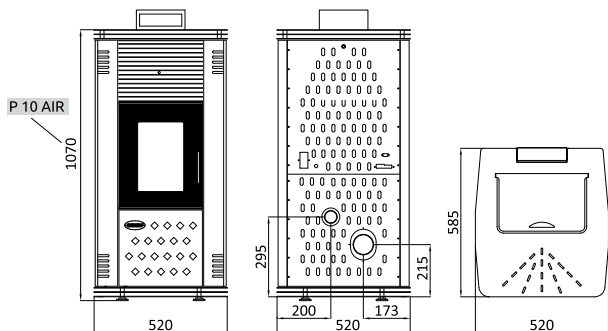

P 12 MODERN
WATER + AIR

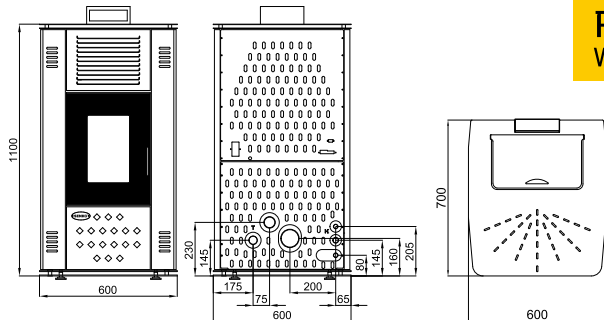

P 20 MODERN
WATER + AIR

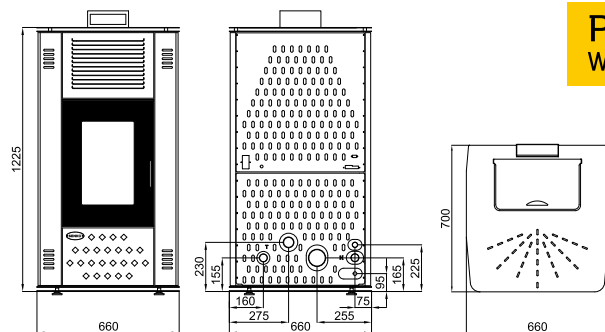

P 10 SLIM MODERN
WATER + AIR

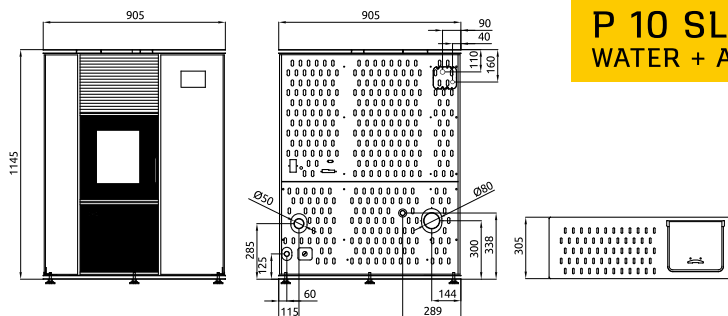

ŠTEDNJACI NA KRUTA GORIVA



ZA CENTRALNO GRIJANJE PROSTORA

Parametar	Jedinica	C-20	C-20 PREMIUM	C-30
Nominalna toplinska snaga	kW	15,8 - 25	15,8 - 25	19,1 - 35
Voda	kW	5,8 - 20	5,8 - 20	5,2 - 23
Prostor	kW	10 - 5	10 - 5	13,9 - 12
Sadržaj vode u kotlu	L	20	20	28
Težina	kg	160	184	200
Grijača ploča (širina x dubina)	mm	457 x 437	457 x 437	567 x 455
Pećnica (širina x dubina x visina)	mm	-	-	-
Priključak dimnjaka	mm	Ø 130	Ø 130	Ø 140
Priključak za ulazak primarnog zraka	mm	Ø 120	Ø 120	Ø 120
Potrebni podtlak dimnjaka	Pa	13	13	15
Učinkovitost	%	84,7	84,7	83,32
Regulacija	primarni zrak	automatski	automatski	automatski
	sekundarni zrak	ručno	ručno	ručno
Zaštita kotla	Priprema za termičku zaštitu od pregrijavanja			
Rešetka ložišta pomična		mehanizam	mehanizam	mehanizam
Visina štednjaka	mm	850 - 920	850 - 920	850 - 920
Vrata ložišta		Vatrootporno staklo		
Razred energetske učinkovitosti		A+	A+	A+



ZA GRIJANJE PROSTORA

Parametar	Jedinica	SG-50	SG-60	SG-60 PREMIUM
Nominalna toplinska snaga	kW	7,2	7,5	7,5
Prostor	kW	7,2	7,5	7,5
Težina	kg	133	151	158
Grijača ploča (širina x dubina)	mm	390 x 440	460 x 438	460 x 438
Pećnica (širina x dubina x visina)	mm	260 x 450 x 200	360 x 450 x 260	360 x 450 x 260
Priključak dimnjaka	mm	Ø 120	Ø 120	Ø 120
Priključak za ulazak primarnog zraka	mm	Ø 80	Ø 80	Ø 80
Potrebni podtlak dimnjaka	Pa	12	12	12
Učinkovitost	%	81,2	82,6	82,6
Regulacija	primarni zrak	ručno	ručno	ručno
	sekundarni zrak	ručno	ručno	ručno
Rešetka ložišta pomična		-	-	-
Visina štednjaka	mm	850 - 920	850 - 920	850 - 920
Vrata ložišta		Vatrootporno staklo		
Razred energetske učinkovitosti		A+	A+	A+



C-25	C-35	C-25 PREMIUM	C-35 PREMIUM
17,2 - 25	21 - 35	17,2 - 25	21 - 35
4,5 - 18	5,4 - 21	4,5 - 18	5,4 - 21
12,7 - 7	15,6 - 14	12,7 - 7	15,6 - 14
20	28	20	28
235	270	260	300
860 x 440	860 x 567	860 x 440	860 x 567
360 x 460 x 260	360 x 600 x 260	400 x 360 x 460	400 x 600 x 360
Ø 130	Ø 150	Ø 130	Ø 150
Ø 120	Ø 120	Ø 120	Ø 120
13	15	13	15
82,9	82,68	82,9	82,68
automatski	automatski	automatski	automatski
ručno	ručno	ručno	ručno
Priprema za termičku zaštitu od pregrijavanja			
mehanizam	mehanizam	mehanizam	mehanizam
850 - 920	850 - 920	850 - 920	850 - 920
Vatrootporno staklo			
A+	A+	A+	A+



SG-75	SG-90
8,1	8,6
8,1	8,6
151	170
640 x 480	787 x 480
330 x 440 x 270	400 x 440 x 230
Ø 120	Ø 120
Ø 80	Ø 80
12	12
87	83,6
ručno	ručno
ručno	ručno
pomična	pomična
850 - 920	850 - 920
Vatrootporno staklo	
A+	A+



KAMINI NA KRUTA GORIVA ZA CENTRALNO GRIJANJE



KAMINI ZA CENTRALNO GRIJANJE

Parametar	Jedinica	C-25	C-35	C-25 MODERN	C-35 MODERN
Nominalna toplinska snaga	kW	12 - 25	20 - 35	12-25	20 - 35
Voda	kW	5 - 20	12 - 31	5 - 20	12 - 31
Prostor	kW	7 - 5	8 - 4	7 - 5	8 - 4
Sadržaj vode u kotlu	L	32	55	32	55
Težina	kg	171	257	160	264
Priključak dimnjaka	mm	Ø 200	Ø 200	Ø 200	Ø 200
Priključak za ulazak primarnog zraka	mm	Ø 120	Ø 150	Ø 120	Ø 150
Potrebni podtlak dimnjaka	Pa	12	16	12	16
Učinkovitost	%	78,6	71,5	78,6	71,5
Regulacija	primarni zrak	automatski	automatski	automatski	automatski
	sekundarni zrak	automatski	automatski	automatski	automatski
Zaštita kotla		Priprema za termičku zaštitu od pregrijavanja			
Vrata ložišta		Vatrootporno staklo			
Razred energetske učinkovitosti		A+	A	A+	A



KAMINSKA SOBNA PEĆ

Parametar	Jedinica	SP	SP / keramička oplata
Nominalna toplinska snaga	kW	5,2	5,2
Prostor	kW	5,2	5,2
Širina	mm	700	700
Dubina	mm	350	350
Visina	mm	825	825
Težina	kg	70	112
Otvor za loženje	š × v (mm)	270 × 212	270 × 212
Priključak dimnjaka	mm	Ø 150	Ø 150
Potrebni podtlak dimnjaka	Pa	12	12
Regulacija	primarni zrak	ručno	ručno
	sekundarni zrak	ručno	ručno
Vrata ložišta		vatrootporno staklo	vatrootporno staklo
Razred energetske učinkovitosti		A	A

PEĆI NA PELETE



MODERN PEĆI NA PELETE ZA CENTRALNO GRIJANJE



Parametar	Jedinica	P 12 MODERN WATER + AIR	P 20 MODERN WATER + AIR	P 10 SLIM MODERN WATER + AIR
Nominalna toplinska snaga	kW	13	19	12
Voda	kW	11,5	16,7	10,3
Prostor	kW	1,5	2,6	1,6
Sadržaj vode u kotlu	L	30,5	35	20
Težina	kg	213	257	165
Potrošnja goriva na nominalnoj snazi*	kg/h*	2,8	4,2	2,7
Kapacitet spremnika	kg	34	54	15
Priključak za ulazak primarnog zraka	mm	Ø 50	Ø 50	Ø 50
Potrebni podtlak dimnjaka	Pa	12	12	12
Učinkovitost na nominalnoj snazi	%	94,95	94,93	90,72
Priključak na električnu mrežu	V / Hz	230 / 50	230 / 50	230 / 50
Regulacija	primarni zrak	automatski	automatski	automatski
	sekundarni zrak	automatski	automatski	automatski
Vrata ložišta		dvostruko staklo	dvostruko staklo	dvostruko staklo
Razred energetske učinkovitosti		A++	A++	A++

MODERN PEĆI NA PELETE ZA GRIJANJE PROSTORA



Parametar	Jedinica	P 10 AIR MODERN
Nominalna toplinska snaga	kW	10
Voda	kW	/
Prostor	kW	10,2
Težina	kg	132
Potrošnja goriva na nominalnoj snazi*	kg/h*	2,3
Kapacitet spremnika	kg	25
Priključak za ulazak primarnog zraka	mm	Ø 50
Potrebni podtlak dimnjaka	Pa	12
Učinkovitost na nominalnoj snazi	%	90,85
Priključak na električnu mrežu	V / Hz	230 / 50
Regulacija	primarni zrak	automatski
	sekundarni zrak	automatski
Vrata ložišta		dvostruko staklo
Razred energetske učinkovitosti		A+



SENCEL
powered by **SENKO**

ELEKTRIČNI KOTLOVI

ZA CENTRALNO GRIJANJE





SENCEL

powered by SENKO

ELEKTRIČNI KOTAO

ZA CENTRALNO GRIJANJE

*Automatizirano, elegantno
i ugodno za okoliš.*

D

Nominalna toplinska snaga	6 - 30 kW
Dimenzije	40×72,1×28,3 cm
Mrežni napon	230/400 V 50 Hz

BOJE



BIJELA



ANTRACIT



COMBI ELEKTRIČNI KOTAO

ZA CENTRALNO GRIJANJE
I PRIPREMU TOPLE VODE

A

COMBI

Nominalna toplinska snaga	15 - 30 kW
Dimenzije	40×77,1×28,3 cm
Mrežni napon	230/400 V 50 Hz



- ▶ Mala dimenzija uređaja svih modela od 6 do 30 KW.
- ▶ Moderan dizajn u dvije boje (bijela i antrazit)
- ▶ Kvalitetne i pouzdane komponente najpoznatijih europskih brendova.
- ▶ Jednostavna redukcija snage.
- ▶ Jednostavna i brza ugradnja.
- ▶ Selektivno i modulacijsko paljenje releja/grijača.
- ▶ Potpuno automatska regulacija snage.
- ▶ Zaštite od pregrijavanja vode, previsokog i preniskog tlaka.
- ▶ Kompletna hydro oprema - sigurnosni ventil, odzračni ventil, termometar pritiska, ekspanziona posuda, pumpa.
- ▶ Način rada ANTIFROST
 - zaštita protiv smrzavanja sustava
 - uključenje uređaja kod temp. vode ispod 5°C.
- ▶ Način rada ANTIBLOCKING
 - zaštita od blokiranja pumpe
 - aktivacija pumpe 1 min svakih 23 h.
- ▶ Način rada TIMER
 - jednostavno i automatsko podešavanje rada u zadanom vremenu.
- ▶ Način rada upravljanja preko sobnog termostata.
- ▶ Način rada upravljanja na osnovu temperature u spremniku vode.
- ▶ WIFI upravljanje
 - aplikacija sa mogućim postavkama temperature i timera.
- ▶ Način rada LJETO - ZIMA
 - ušteda energije.
- ▶ Dostupni modeli 6, 9, 12, 15, 18, 22.5, 24 i 30 kW SENel za centralno grijanje i SENel COMBI za centralno grijanje i pripremu tople vode od 15, 18, 22.5, 24 i 30 kW.



ELEKTRIČNI KOTLOVI za centralno grijanje

Parametar	Jedinica	6	9	12	15
Nominalna toplinska snaga	kW	6	9	12	15
Mrežni napon	Vac	1x230 50 Hz		3x400/230 50 Hz	
Električni grijači	kom x kW	2x3	1x3-1x6	2x6	2x7,5
Maksimalna temperatura rada	°C	75	75	75	75
Maksimalni radni pritisak	bar	3	3	3	3
Priključak polazne cijevi	col	G3/4	G3/4	G3/4	G3/4
Priključak povratne cijevi	col	G3/4	G3/4	G3/4	G3/4
Sadržaj vode u kotlu	l	7	7	7	7
Volumen ekspanziona posude	l	6	6	6	6
Dimenzije (š x v x d)	mm	400x721x283	400x721x283	400x721x283	400x721x283
Masa uređaja	kg	31	31	31	31
Energetski razred		D	D	D	D

COMBI ELEKTRIČNI KOTLOVI za centralno grijanje i pripremu tople vode

Parametar	Jedinica	15	18
Nominalna toplinska snaga	kW	15	18
Mrežni napon	Vac	3x400/230 50 Hz	
Električni grijači	kom x kW	2x7,5	3x6
Maksimalna temperatura rada	°C	75	75
Maksimalni radni pritisak	bar	3	3
Priključak polazne cijevi	col	G3/4	G3/4
Priključak povratne cijevi	col	G3/4	G3/4
Sadržaj vode u kotlu	l	7	7
Volumen ekspanziona posude	l	6	6
Dimenzije (š x v x d)	mm	400x771x283	400x771x283
Masa uređaja (bez vode)	kg	35	36
Energetski razred		A	A



18	22,5	24	30
18	22,5	24	30
3x400/230 50 Hz			
3x6	3x7,5	4x6	4x7,5
75	75	75	75
3	3	3	3
G3/4	G3/4	G3/4	G3/4
G3/4	G3/4	G3/4	G3/4
7	7	7	7
6	6	6	6
400x721x283	400x721x283	400x721x283	400x721x283
32	32	34	34
D	D	D	D



22,5	24	30
22,5	24	30
3x400/230 50 Hz		
3x7,5	4x6	4x7,5
75	75	75
3	3	3
G3/4	G3/4	G3/4
G3/4	G3/4	G3/4
7	7	7
6	6	6
400x771x283	400x771x283	400x771x283
36	37	37
A	A	A



SENKO

Vladimira Nazora 22, Štefanec, 40000 Čakovec, Hrvatska

Tel: +385 (0)40 33 73 44 • E-mail: info@senko.hr

www.senko.hr

facebook. YouTube



Moguće su eventualne razlike u nijansama prikazanih boja proizvoda. Nijanse se mogu razlikovati od onih u stvarnosti. Svi relevantni tehnički podaci su dobiveni u laboratorijskim (idealnim) uvjetima. Odstupanja su moguća. Zadržavamo pravo promjene svih tehničkih detalja i boja svih proizvoda navedenih u ovom katalogu bez prethodnog upozorenja.

04-2025